



GEARS



ELBADR Industries

COMPANY CATALOG

GEARS IN MOTION BUSINESS IN PROMOTION

Sudan Algeria Tunisia Rign Road Marg Trade
Europe Africa Middle East Industries Egypt
Export China **EL BADR Ind.**
Morocco Lebanon **Factory** Import
Cairo Codes ISO 9001:2015 Environment Safty ISO
Teeth Rolls Management Fe Iron Plastic Cars
Surface Grinding Joints Bronze **Metal** Automotive
Mechanics **GearBOX** Heat Steel Nonferrous
Raw Material Design Suppliers
Herringbonge Maintenance Production Lines Milling
Autocad Drawings **Services** Enginering
Shafts Heilical Consultations
Rack & Pinion Reverse Engineering Design
Sprockets **Gears** Oil Cutting Germany
Spur Planetary CNC **Machines**
Products Tools Argon Lathe Turning
Cold Spray CO2 Drilling Honed
Bevel Rod **GasWelding** Pin Pharos Ceramic
Essel Propack Centers O2 Obourland for food industries
EL Nakhala Tobacco Gloria Suez Canal Authority
Constructions Ceramic Food Co. Arab Contractors
Hassan Allam Royal **Clients** Private Sector
Government Sector
Sarhan For Marble & Granite ACRO Group EGTS
Marbella For Food Industries Ceramica Cleopatra
Nag Hamady Sugar Factory Hwamdya Sugar Factory
Manufacturing Commercial Vehicles **ELCO STONE**
Nile pharma Alfa Cement Free Foods Co. Luna Group
Talat Mostafa Group Ceramica Alfa Heidelberg Cement G
Egypt Air Compass Group **MCV RIGO Automak**



CONTENT

COMPANY CATALOG

● ABOUT ELBADR.....	(2).
● WHAT WE DO.....	(4).
● CLIENTS.....	(6).
● SPUR GEARS.....	(10).
● HELICAL GEARS.....	(11).
● HERRINGBONE GEARS.....	(12).
● SPROCKET GEARS.....	(13).
● BEVEL GEARS.....	(14).
● RACK & PINION.....	(16).
● INTERNAL GEARS.....	(17).
● WORM AND WORM GEARS.....	(18).
● PLANETARY GEARS.....	(19).
● GEARBOXES MANUFACTURING.....	(20).
● GEARBOXES MAINTENANCE.....	(22).
● MECHANICAL PARTS.....	(24).
● CNC PRODUCTS.....	(26).
● STEEL STRUCTURE.....	(30).
● SHEET METAL.....	(31).
● IMPELLER FAN.....	(33).
● CERAMIC PRODUCTS.....	(34).
● FAIRS & EVENTS.....	(38).
● WHY ELBADR.....	(39).
● QUALITY.....	(40).
● CONNECT WITH US.....	(41).



ABOUT ELBADR

El Badr Industries is a pioneering leader in manufacturing, specializing in precision gears, gearboxes, turning, grinding, sharpening, and heat treatment.

Since its establishment in 2007, the company has successfully competed with major Egyptian firms in the metal industrial manufacturing sector, mastering gear production and general turning for a wide range of medium and heavy industries. Elbadr Industries is committed to producing high-quality products, earning the ISO 9001 certification in 2008. The company was also the first to implement the updated ISO 9001:2015 standards in its field.

CAPABILITIES

- SKILLED LABOR GUIDED BY TALENTED ENGINEERS.
- 18 YEARS OF EXPERIENCE IN METAL WORKS.
- WIDE RANGE OF PRODUCTS AND SERVICES.
- PIONEER ADMINISTRATIVE STAFF.
- QUALITY MANAGEMENT SYSTEM.
- HIGH QUALITY RAW MATERIAL.
- CUTTING-EDGE MACHINERY.
- PACKAGING & EXPORT.

2007

Founded

158

Industrial clients

+10,000

Products

ABOUT ELBADR

VISION

"TO BE THE LEADING PROVIDER OF HIGH-QUALITY METAL FABRICATION AND GEAR MANUFACTURING SOLUTIONS IN EGYPT AND THE MENA REGION, DRIVING INNOVATION, SUSTAINABILITY, AND EXCELLENCE IN EVERY PRODUCT WE DELIVER."

MISSION

"TO DELIVER PRECISION-ENGINEERED GEARS AND METAL COMPONENTS THAT MEET THE HIGHEST STANDARDS OF QUALITY AND PERFORMANCE. WE ARE COMMITTED TO PROVIDING EXCEPTIONAL CUSTOMER SERVICE, INVESTING IN ADVANCED TECHNOLOGIES, AND FOSTERING A CULTURE OF CONTINUOUS IMPROVEMENT AND INNOVATION TO SUPPORT THE DIVERSE NEEDS OF INDUSTRIES ACROSS EGYPT AND BEYOND."

VALUES

LEADERSHIP
INTEGRITY
QUALITY
INNOVATION





WHAT WE DO

1. MANUFACTURING



ELBADR INDUSTRIES ARE MANUFACTURERS OF CUSTOM PRECISION GEARS AND MECHANICAL PARTS TO SPECIFICATION FROM CLIENT DESIGNS, SAMPLES AND CUSTOMER DRAWINGS. WE ARE PROUDLY MANUFACTURERS OF THE FOLLOWING:

- ALL KINDS OF GEAR AND GEARBOXES.
- WIDE RANGE OF MECHANICAL PARTS.
- ALL KINDS OF JOINTS AND BUSHES.
- ALL KINDS OF SHAFTS AND ROLLS.
- SHEET METAL FABRICATION.
- ALL KINDS OF SPLINES.
- ALL KINDS OF CAMS.
- CNC PRODUCTS.



2. REVERSE ENGINEERING

ANALYZING AN EXISTING PARTS, MACHINES AND MECHANICAL COMPONENTS TO CREATE DUPLICATES, MODIFYING OR ENHANCING EXISTING DESIGNS.

WHAT WE DO

3. CONSULTATIONS



WITH OUR LONG HISTORY AND EXPERIENCE IN THE METAL FABRICATION INDUSTRY, WE ARE NOW PROVIDERS OF A WIDE RANGE OF CONSULTATION SERVICES FOR INDUSTRIAL STARTUPS AS WELL AS LARGE FACTORIES.



4. MAINTENANCE

IN THE WORLD OF MECHANICS, SYSTEMATIC & ACCURATE MAINTENANCE PROCEDURES CAN SAVE YOUR COMPANY MILLIONS OF DOLLARS, THAT'S WHY WE CONSIDER MAINTENANCE AS ONE OF THE IMPORTANT SECTORS WE OPERATE IN.

CLIENTS

CERAMIC COMPANIES

- GEMMA CERAMIC.
- CERAMICA CLEOPATRA.
- ART CERAMIC.
- ROYAL CERAMIC.
- GLORIA CERAMIC.
- MAYORCA CERAMIC.
- CERAMIC ALFA.
- CERAMIC REMAS.
- FARSINA CERAMIC.
- VENEZIA CERAMICA.
- PLATINO CERAMICA.
- MAJESTIC PORCELAIN.
- CERAMICA LENTO.
- OMEGA CERAMICS.
- CERAMICA PRIMA.
- CERAMICA GRANITO.
- AMIR CERAMICS.

GEMMA  الجوهرة
ceramic sponsor شريكنا التجاري



Gloria.
ceramic



ceramica
VENEZIA



Art
Ceramic



ceramica
REMAS



CERAMICA
RANITO

Majestic

OMEGA CERAMICS
شركتنا التجارية



ALFA
CERAMIC
FOR YOUR LIFE

CLIENTS

FOOD COMPANIES

- CANAL SUGAR.
- FREE FOODS CO.
- NILE SUGAR.
- MARBELLA FOR FOOD INDUSTRIES.
- NAG HAMADY SUGAR FACTORY.
- OBOURLAND FOR FOOD INDUSTRIES.
- AL NOUR FOR DAIRY INDUSTRIES.
- HWAMDYA SUGAR FACTORY.



CLIENTS

CONSTRUCTION COMPANIES

- ARABIAN CEMENT.
- TITAN CEMENT INTERNATIONAL.
- EZZ STEEL.
- TALAT MOSTAFA GROUP - ALEXANDRIA COMPANY FOR CONSTRUCTIONS.
- ROYAL EL MINYA CEMENT.
- ACRO MISR.
- SUEZ CANAL AUTHORITY - ATAQA QUARRY.
- HEIDLBERG MATERIALS.
- ASHRY STEEL.
- EGYPTIAN STEEL.
- SOUTH VALLEY CEMENT.
- CONCORD EL MASRYA
- PHOENIX BIRD FOR STEEL RE ROLLING



CLIENTS

OTHER COMPANIES

- EGYPT AIR.
- ESSEL PROPACK.
- NILE PHARMA.
- LASHEEN PLASTIC COMPANY.
- MCV -MANUFACTURING COMMERCIAL VEHICLES.
- THE EGYPTIAN CHINESE J.V. COMPANY FOR INVESTMENT.
- MANUFACTURING COMMERCIAL VEHICLES.
- GUARDIAN GLASS.
- SPHINX GLASS.
- EL NAKHALA TOBACCO.
- EVA PHARMA.
- ALEXANDRIA PETROLEUM CO.



SPUR GEARS



HELICAL GEARS





SPROCKET GEARS



SPROCKET GEARS

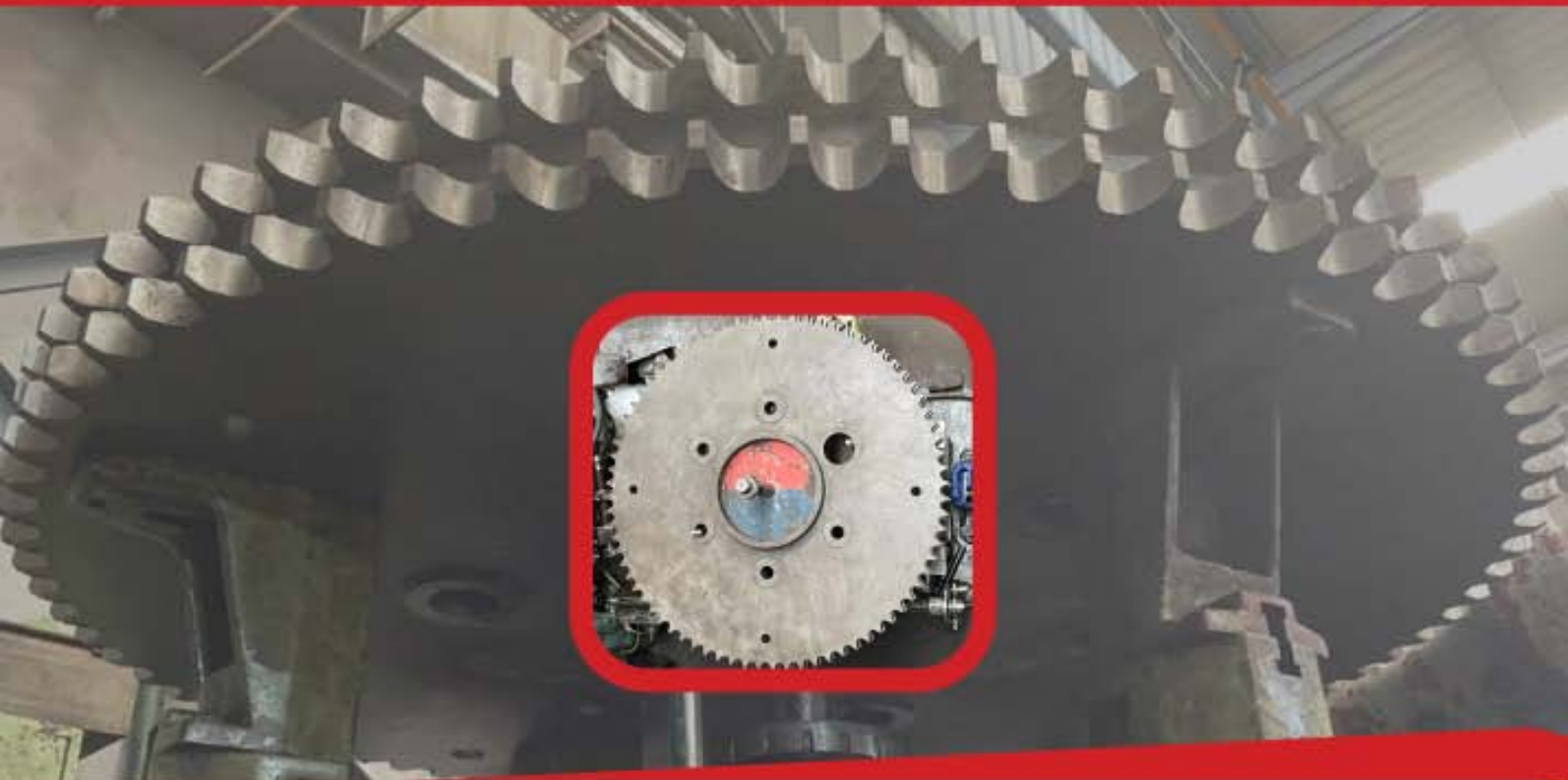

HERRINGBONE GEARS

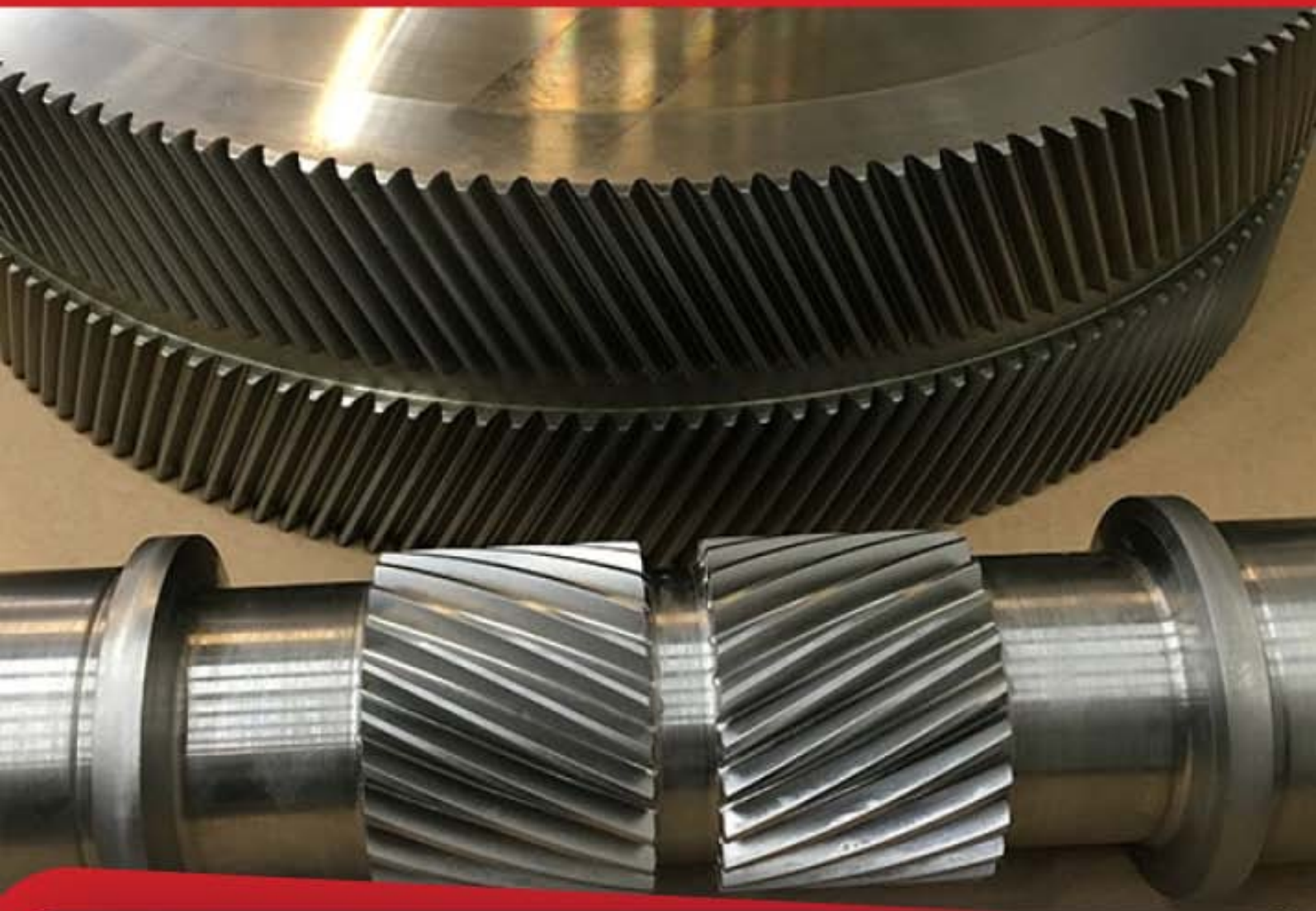

BEVEL GEARS





**SPIRAL BEVEL
MACHINES**

A close-up photograph of a spiral bevel machine in operation. The machine features a large, multi-toothed spiral gear that is being milled by a cutting tool. The scene is filled with bright sparks and a mist of metal chips, indicating a high-speed manufacturing process. The background shows the industrial structure of the machine.



**SPIRAL
TESTING
MACHINE**

A photograph of a spiral testing machine. The machine consists of a large, circular gear with many teeth, mounted on a horizontal shaft. The gear is being tested by a smaller gear. The machine is housed in a large, industrial-looking structure with a metal mesh fence. The background shows a factory setting with overhead lights.

RACK & PINION



INTERNAL GEARS





PLANETARY GEARS

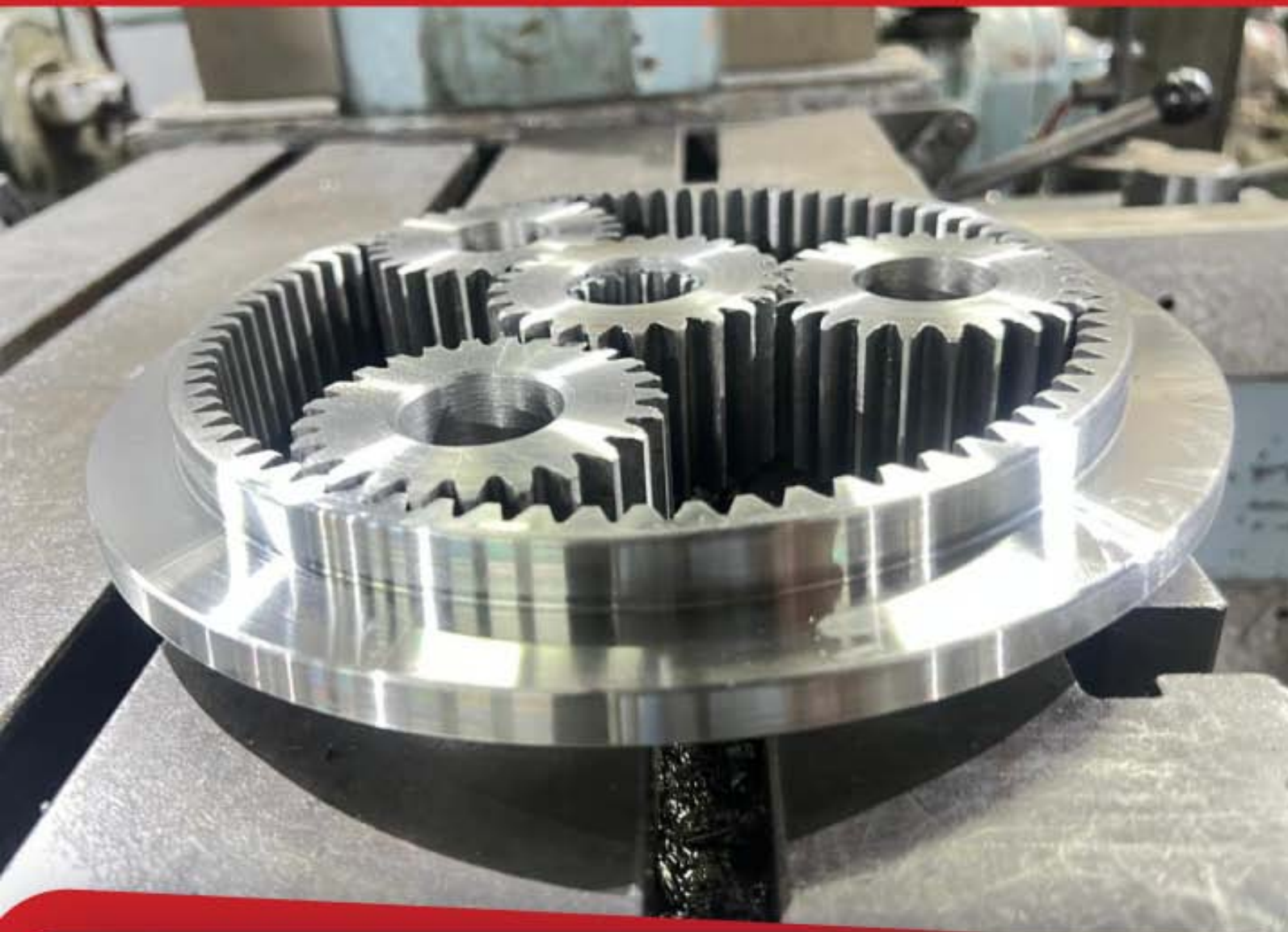

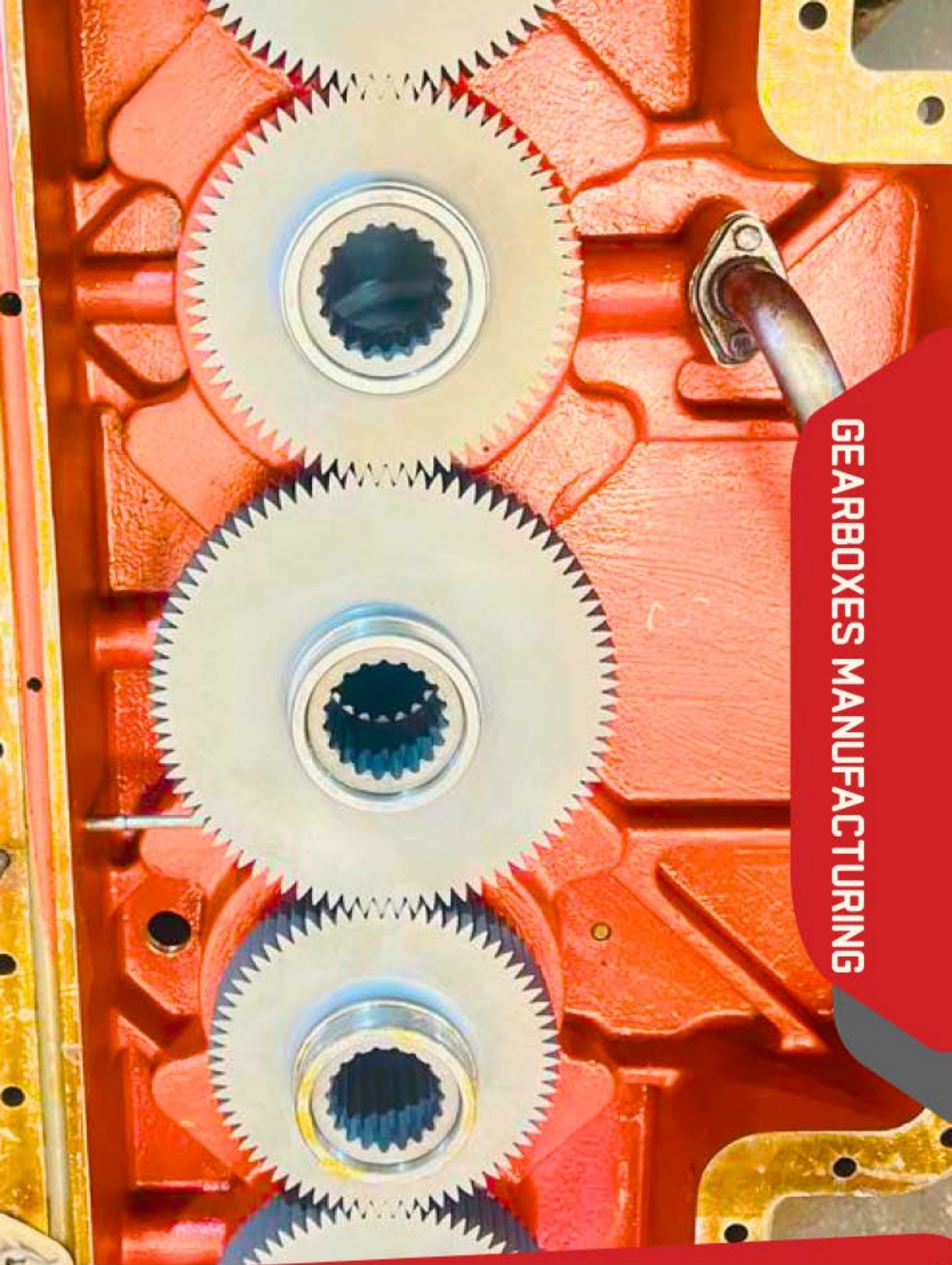

GEARBOXES MANUFACTURING



GEARBOXES MANUFACTURING



GEARBOX MAINTENANCE



BEFORE



AFTER



BEFORE

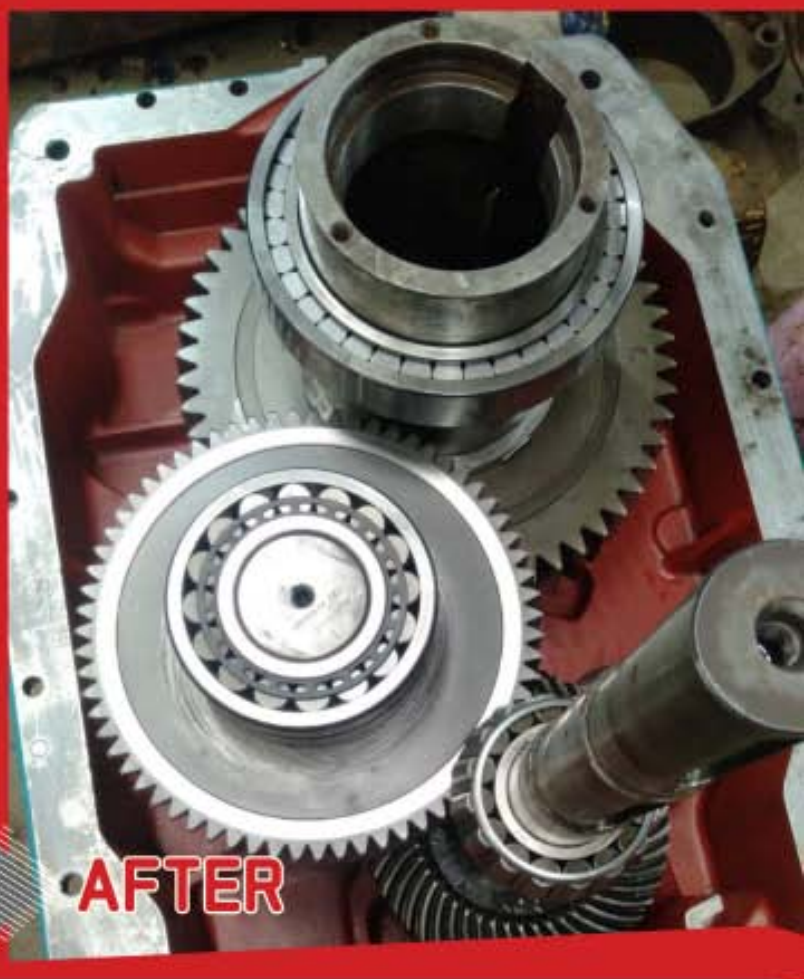

AFTER

GEARBOX MAINTENANCE



MECHANICAL PARTS



MECHANICAL PARTS





CNC PRODUCTS

CNC
4 AXIS 5 AXIS





CNC PRODUCTS

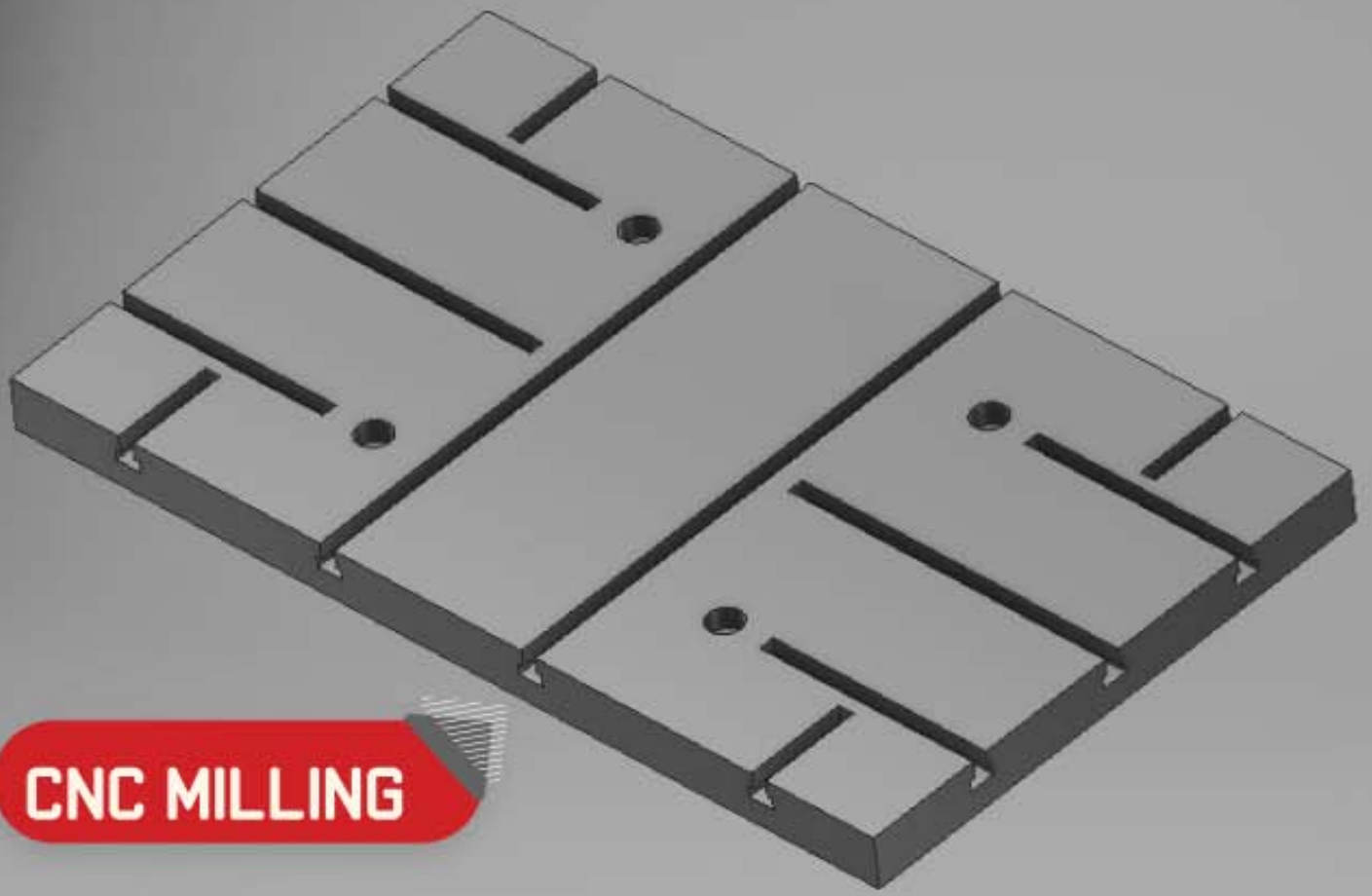

CNC MILLING



CNC
4 AXIS 5 AXIS

CNC PRODUCTS



MASS PRODUCTION

STEEL STRUCTURE

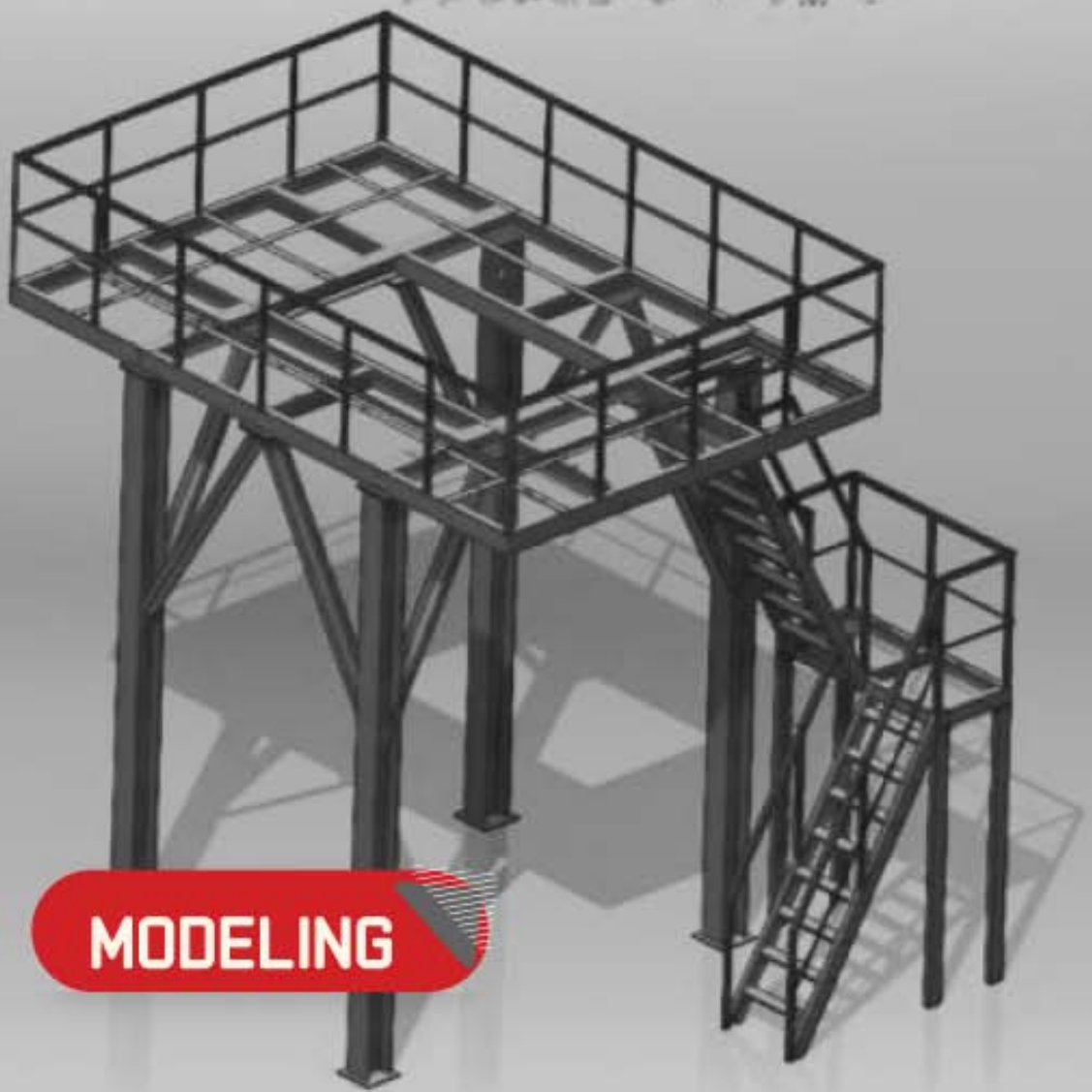

MODELING



FINAL PRODUCT

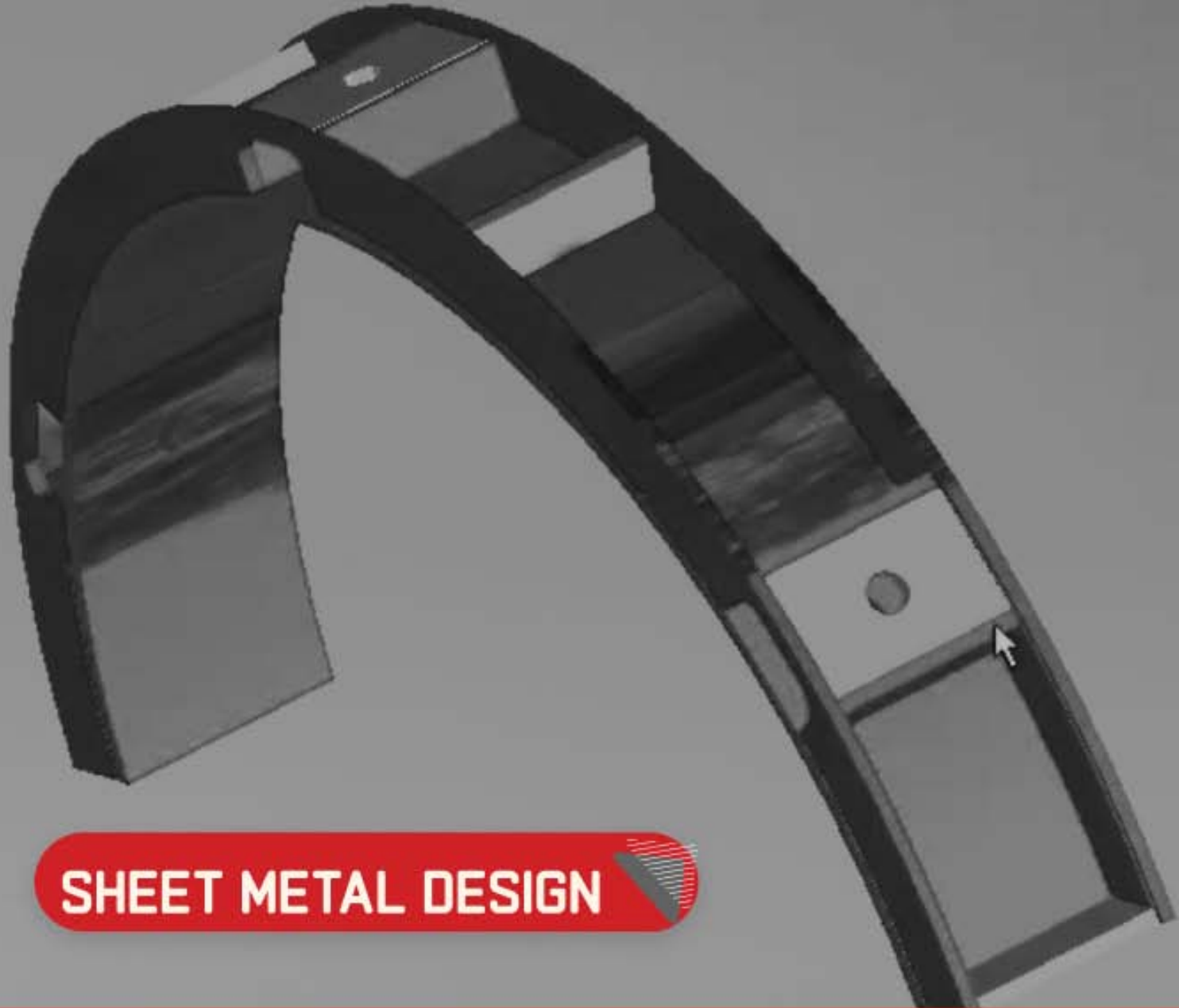

SHEET METAL DESIGN



FINAL PRODUCT



SHEET METAL

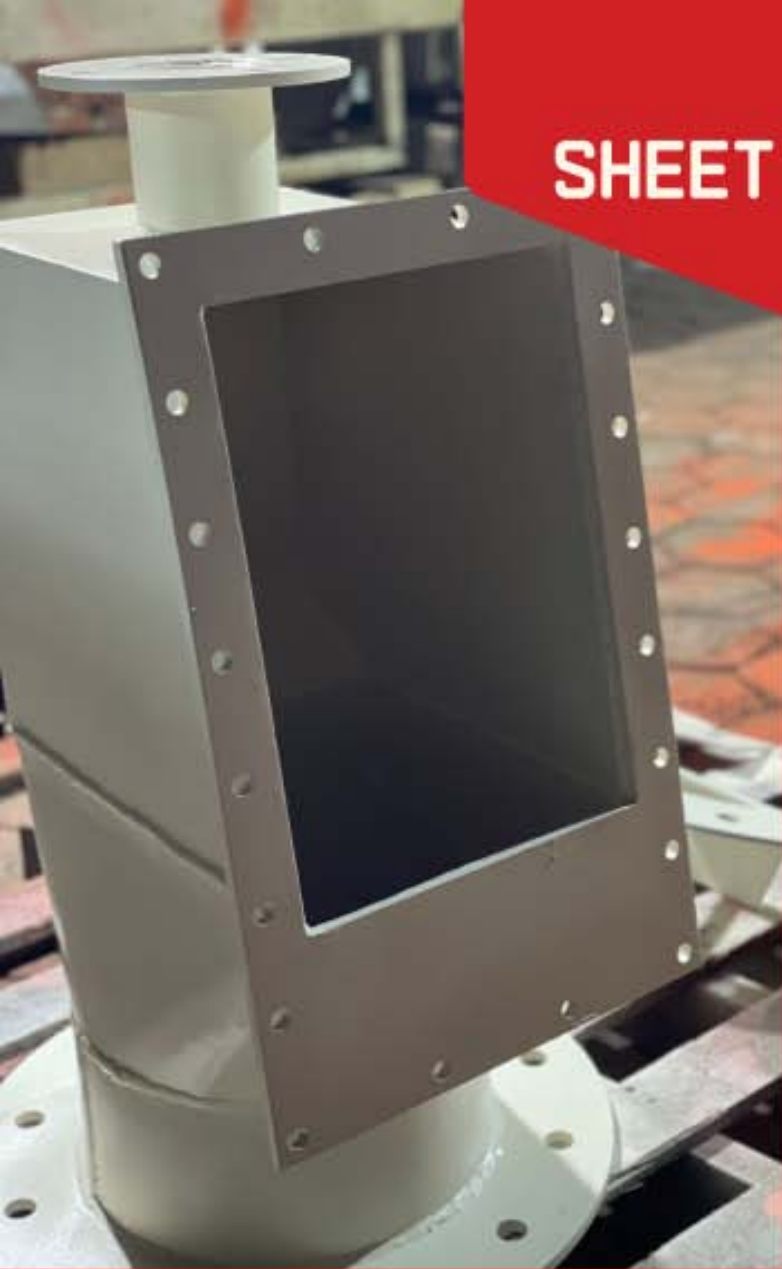

DESIGN

IMPELLER FAN

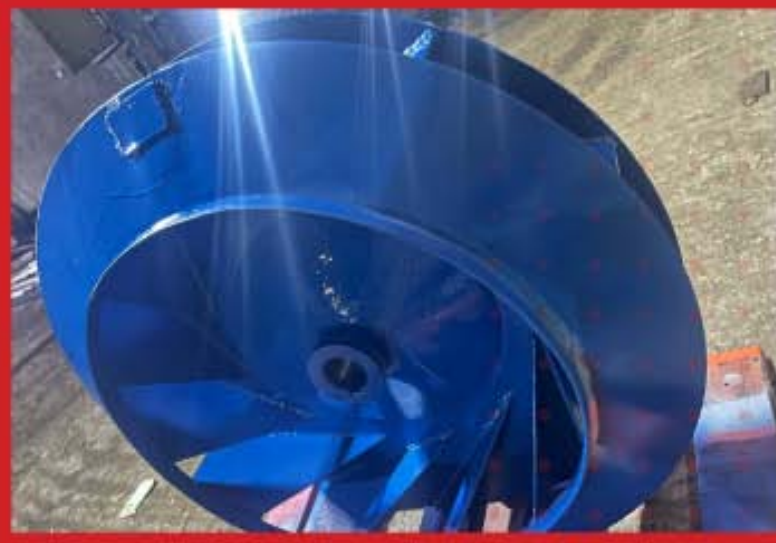
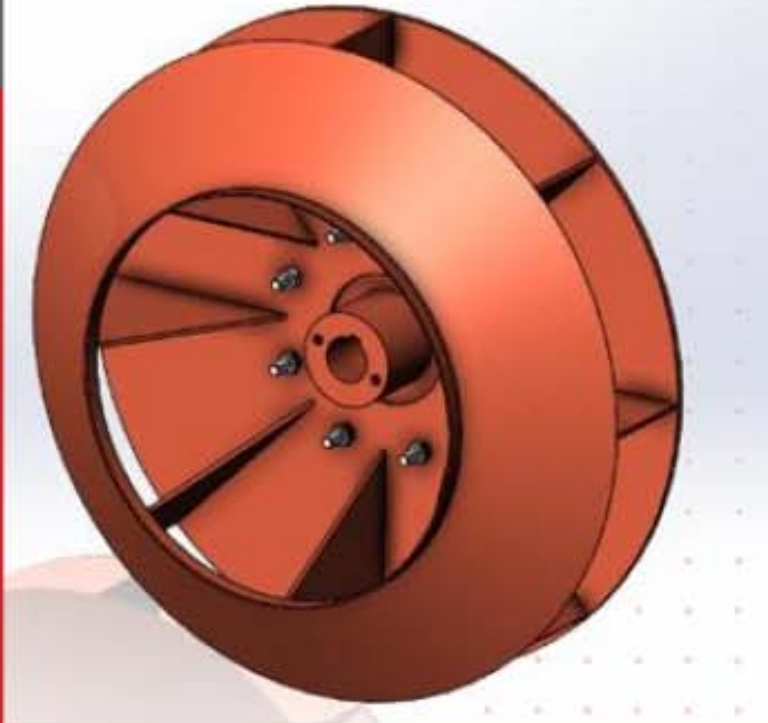
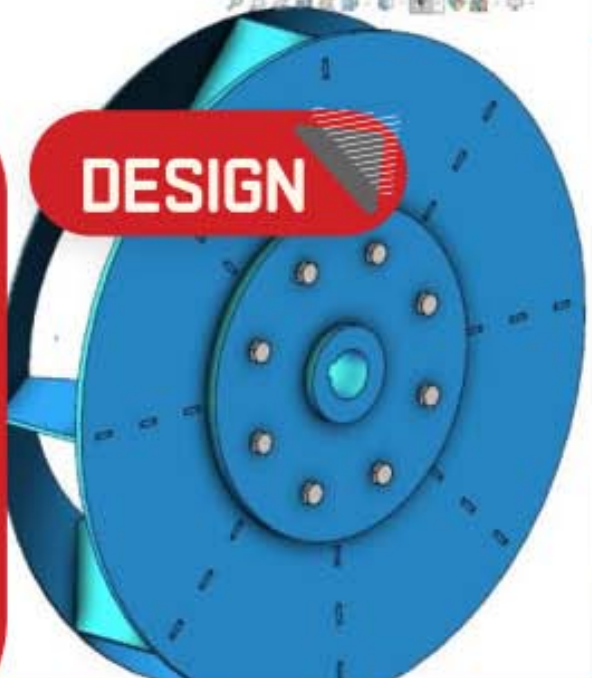

CERAMIC FACTORIES PRODUCTS



SPINDLE CUP



BATCH MILL PULLEY



BEARING HOUSING

CERAMIC FACTORIES PRODUCTS



POLISHING SPINDLE SLEEVES



SLIP PUMP BODY



SLIP PUMP VALVE



SLIP PUMP VALVE



CONTINUOUS MILL DRIVE PULLEY

CERAMIC PRODUCTS



RAW MATERIAL SHAKER

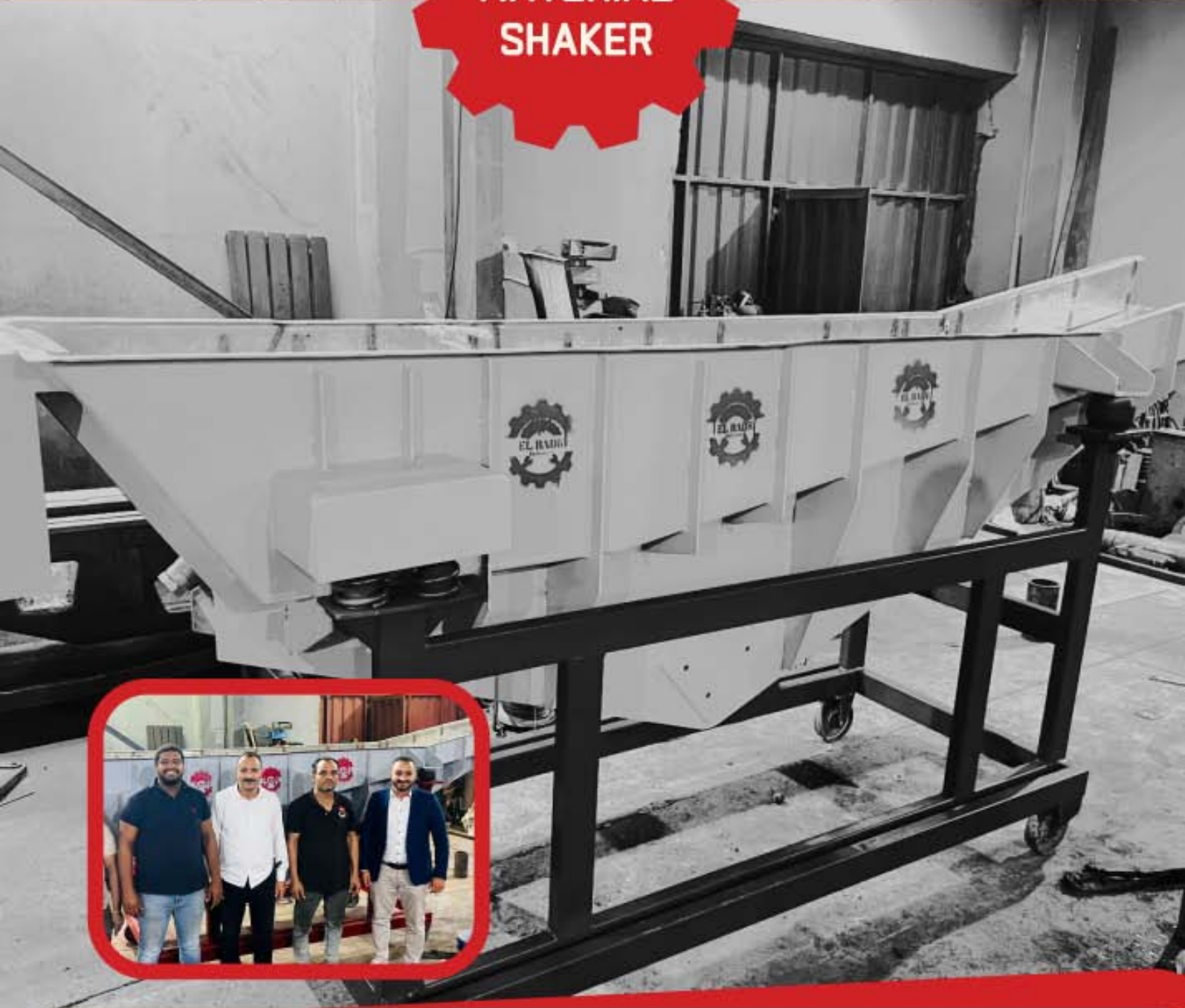

RAW MATERIAL FEEDER

PRODUCTS



CERAMIC
INDUSTRY

FAIRS & EVENTS

ITALY



CHINA



EGYPT

TÜRKIYE



GERMANY



WHY ELBADR ?



**MODERN
MACHINERY**

**HIGH QUALITY
RAW MATERIAL**

**SKILLED
LABOR**

**INNOVATIVE
ENGINEERS**

**PIONEER
ADMINISTRATIVE
STAFF**

QUALITY FIRST



Certificate of Registration

Certificate No: 150811012001

This is Certify that the Management System of the

**ELBADR FOUNDATION FOR GENERAL SUPPLIES
AND METAL WORKS**

**MAHMOUD HELMY STREET FROM FARAJ EL HAWARY
FROM ALJAZIRA - EL-MARG - CAIRO - EGYPT**

*Has been assessed and found to be in accordance with the requirements of
Standard detailed below*

ISO 9001 : 2008

This Certificate is valid for the following scope

**"Manufacturing of Gears and Gear boxes and providing
General turning services"**

Initial Registration Date	11 th Aug. 2015	Issue Date	11 th Aug. 2015
1 Surveillance on or before	11 th July 2016	Valid Until	10 th Aug. 2018
2 Surveillance on or before	11 th July 2017		

*To check validity of the certificate please
Visit www.isoindia.org or call at given numbers*



JAS-ANZ



Managing Director

TNV Certification Pvt Ltd.

Accredited by Joint Accreditation
System of Australia and New Zealand

HO: 537-B/187-B, Amber Vihar, Nr. CBI, Keshav Nagar, Sitapur Road, Lucknow-226020, (UP), India

Ph: +91-522-2756327-328, +91-9935002362, Fax: +91-522-2759881, email: info@isoindia.org, www.isoindia.org

*Validity of certificate is subject completion of surveillance audit. Further clarification regarding the scope of this certificate and the applicability of standards may be obtained by consulting the organization. This certificate remains property of TNV Certification Pvt Ltd. And must be retained on request. ISO, IAF, JAS-ANZ, Joint Accreditation System of Australia & New Zealand is www.jas-anz.org

QUALITY FIRST



CONNECT WITH US



SEARCH

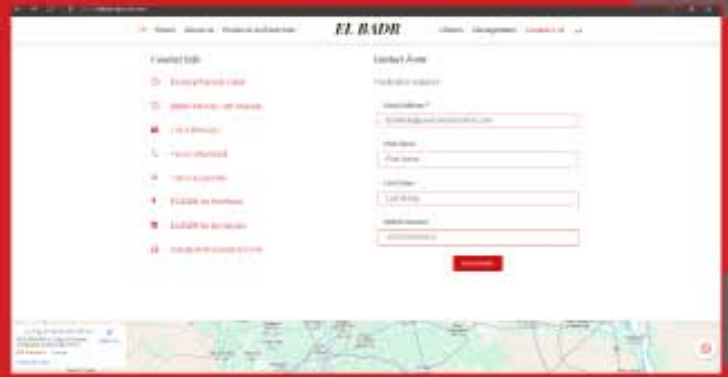

WEBSITE

FACEBOOK

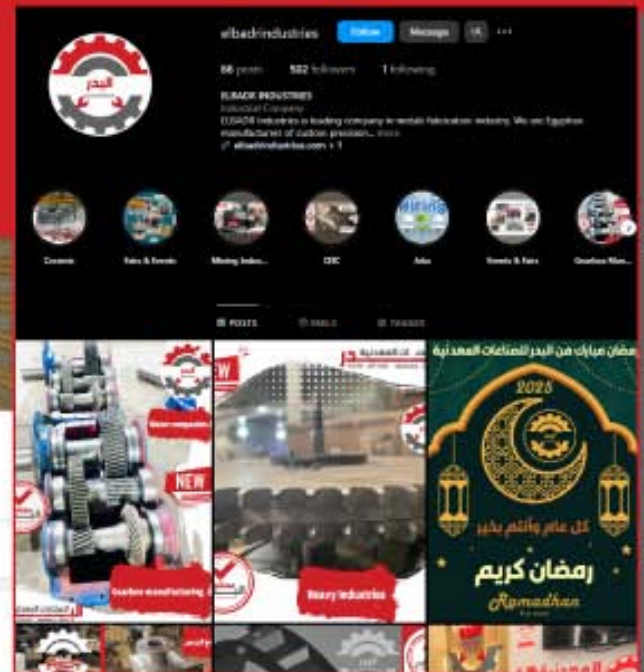

INSTAGRAM

Sudan Algeria Tunisia Rign Road Marg Trade
Europe Africa Middle East Industries Egypt
Export China **EL BADR Ind.**
Morocco Lebanon **Factory** Import
Cairo Codes ISO 9001:2015 Environment Safty ISO
Teeth Rolls Management Fe Iron Plastic Cars
Surface Grinding Joints Bronze **Metal** Automotive
Mechanics **GearBOX** Heat Steel Nonferrous
Raw Material Design Suppliers
Herringbonge Maintenance Production Lines Milling
Autocad Drawings **Services** Engineering
Shafts Heilical Consultations
Rack & Pinion Reverse Engineering Design
Sprockets **Gears** Oil Cutting Germany
Spur Planetary CNC **Machines**
Products Tools Argon Lathe Turning
Cold Spray CO2 Drilling Honed
Bevel Rod **GasWelding** Pin Pharos Ceramic
Essel Propack Centers O2 Obourland for food industries
EL Nakhala Tobacco Gloria Suez Canal Authority
Constructions Ceramic Food Co. Arab Contractors
Hassan Allam Royal **Clients** Private Sector
Government Sector
Sarhan For Marble & Granite ACRO Group EGTS
Marbella For Food Industries Ceramica Cleopatra
Nag Hamady Sugar Factory Hwamdya Sugar Factory
Manufacturing Commercial Vehicles ELCO STONE
Nile pharma Alfa Cement Free Foods Co. Luna Group
Talat Mostafa Group Ceramica Alfa Heidelberg Cement G
Egypt Air Compass Group MCV RIGO Automak

BEST IN EGYPT



ELBADR INDUSTRIES

METAL FABRICATOR

GEARS IN MOTION BUSINESS IN PROMOTION



01008460338



01033506322



INFO@ELBADRINDUSTRIES.COM



WWW.ELBADRINDUSTRIES.COM



CREATIVE@MITSOLUTIONS.ME